



V6

6 Cutting Corner Inserts



INCH

V6 A Revolutionary 6 Cutting Corner System

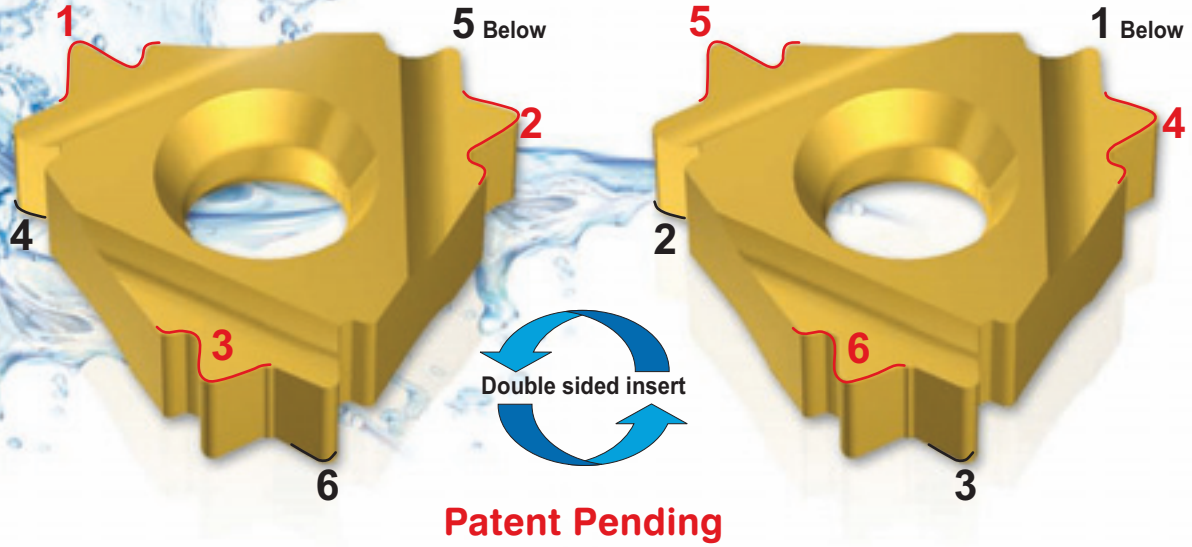

V6 Features:

- 6 Cutting corners
- Fits standard holders
- Economical insert for lower tooling costs
- Same application on all corners
- Doubles your tool life



TT GEN software and updated versions can be downloaded from www.vargususa.com

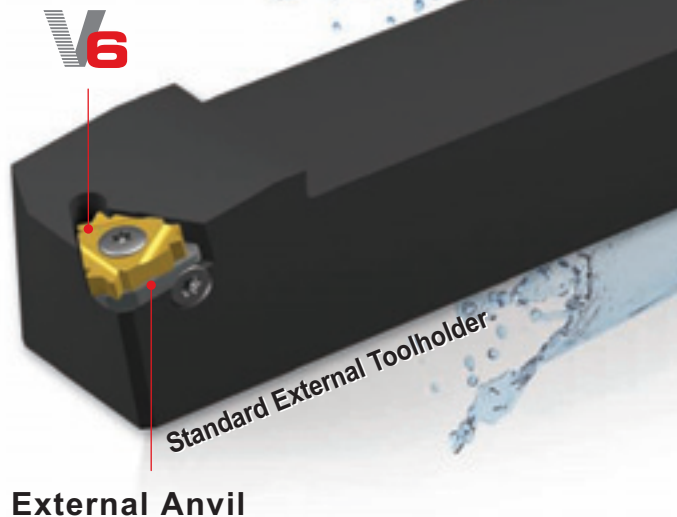
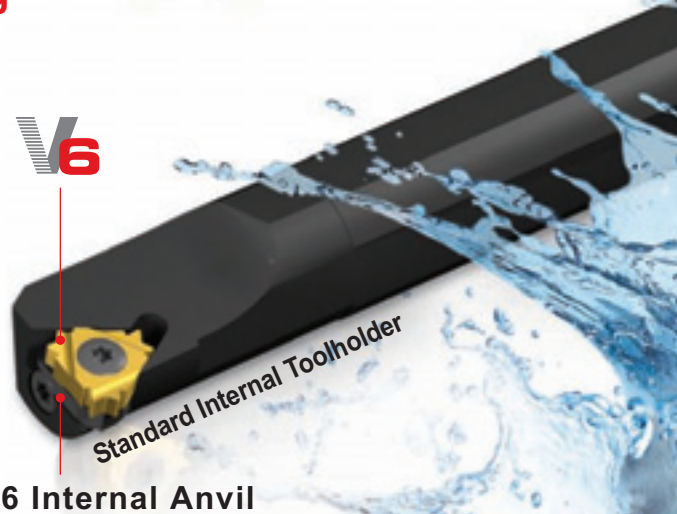

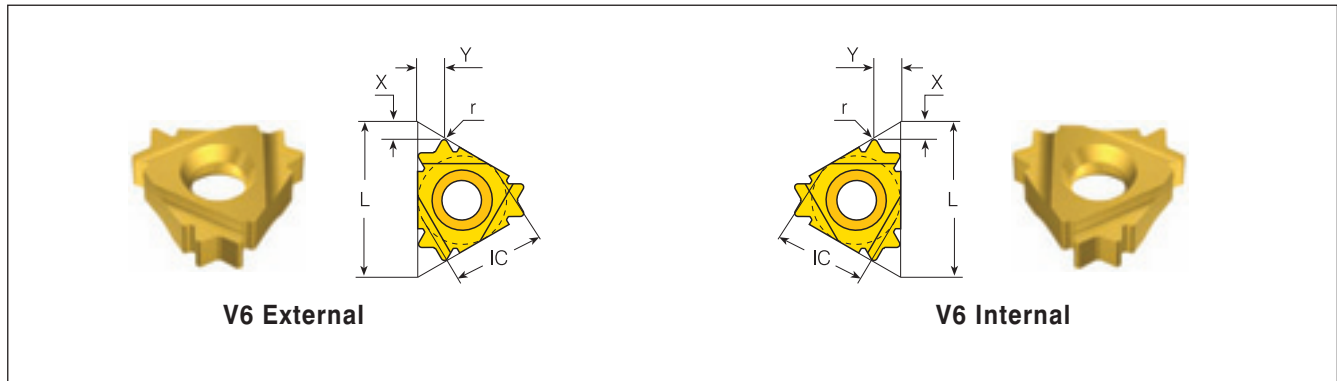

V6 External

V6 Internal

Partial 60°

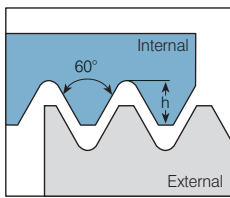

	Insert Size		Pitch		Ordering Code	EDP No.	Dimensions [inch]			V6 Anvil	
	IC	L[inch]	mm	tpi	RH	VKX	r	X	Y	RH	Toolholder
External	3/8" V6	.63	0.5-2.0	48-13	3ERS60-6C...	59528	.002	.08	.12	YE3-6C	AL...-3
Internal	3/8" V6	.63	0.5-2.0	48-14	3IRS60-6C...	59547	.001	.06	.10	YI3-6C	AVRC...-3 NVRC...-3V6

Partial 55°

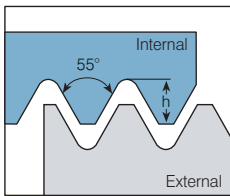

	Insert Size		Pitch		Ordering Code	EDP No.	Dimensions [inch]			V6 Anvil	
	IC	L[inch]	mm	tpi	RH	VKX	r	X	Y	RH	Toolholder
External	3/8" V6	.63	-	48-14	3ERS55-6C...	59529	.002	.07	.11	YE3-6C	AL...-3
Internal	3/8" V6	.63	-	48-16	3IRS55-6C...	59546	.002	.06	.10	YI3-6C	AVRC...-3 NVRC...-3V6

ISO

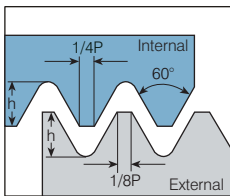

Defined by: R262 (DIN 13)
Tolerance class: 6g/6H

	Insert Size		Pitch		Ordering Code	EDP No.	Dimensions [inch]			V6 Anvil	
	IC	L[inch]	mm		RH	VKX	h min	X	Y	RH	Toolholder
External	3/8" V6	.63	0.5		3ER0.5ISO-6C...	59522	.012	.09	.07	YE3-6C	AL...-3
			0.75		3ER0.75ISO-6C...	59523	.018	.08	.07		
			0.8		3ER0.8ISO-6C...	59524	.019	.08	.08		
			1.0		3ER1.0ISO-6C...	59520	.024	.08	.09		
			1.25		3ER1.25ISO-6C...	59525	.030	.07	.09		
			1.5		3ER1.5ISO-6C...	59521	.036	.07	.10		
			1.75		3ER1.75ISO-6C...	59526	.042	.07	.10		
			2.0		3ER2.0ISO-6C...	59527	.060	.07	.11		
Internal	3/8" V6	.63	0.5		3IR0.5ISO-6C...	59564	.011	.08	.07	YI3-6C	AVRC...-3 NVRC...-3V6
			0.75		3IR0.75ISO-6C...	59565	.017	.08	.07		
			0.8		3IR0.8ISO-6C...	59566	.018	.07	.07		
			1.0		3IR1.0ISO-6C...	59570	.023	.08	.08		
			1.25		3IR1.25ISO-6C...	59567	.028	.07	.07		
			1.5		3IR1.5ISO-6C...	59571	.034	.06	.09		
			1.75		3IR1.75ISO-6C...	59568	.040	.06	.09		
			2.0		3IR2.0ISO-6C...	59569	.045	.07	.10		

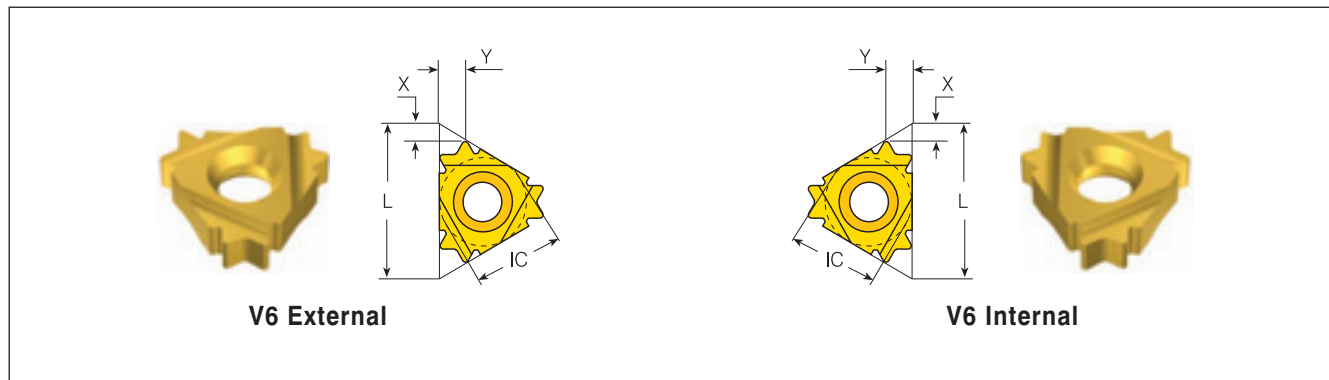

UN

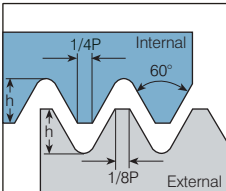
	Insert Size		Pitch	Ordering Code	EDP No.	Dimensions [inch]			V6 Anvil	
	IC	L [inch]	tpi	RH	VKX	h min	X	Y	RH	Toolholder
 <p>Defined by: ANSI B1.1.74 Tolerance class: 2A/2B</p>	3/8" V6	.63	32	3ER32UN-6C...	59530	.019	.08	.08	YE3-6C	AL...-3
			28	3ER28UN-6C...	59531	.022	.08	.08		
			24	3ER24UN-6C...	59532	.026	.07	.08		
			20	3ER20UN-6C...	59533	.031	.07	.09		
			18	3ER18UN-6C...	59534	.034	.07	.09		
			16	3ER16UN-6C...	59535	.038	.07	.10		
			14	3ER14UN-6C...	59536	.044	.07	.11		
			13	3ER13UN-6C...	59537	.047	.08	.11		
<p>Internal</p>	3/8" V6	.63	32	3IR32UN-6C...	59563	.020	.08	.07	YI3-6C	AVRC...-3 NVRC...-3V6
			28	3IR28UN-6C...	59562	.020	.07	.08		
			24	3IR24UN-6C...	59561	.024	.07	.08		
			20	3IR20UN-6C...	59560	.029	.07	.09		
			18	3IR18UN-6C...	59557	.032	.07	.09		
			16	3IR16UN-6C...	59555	.036	.06	.09		
			14	3IR14UN-6C...	59553	.041	.07	.10		
			13	3IR13UN-6C...	59550	.044	.07	.11		
			12	3IR12UN-6C...	59548	.048	.06	.10		

BSW

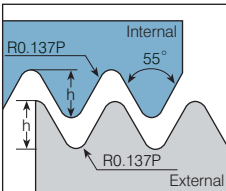
	Insert Size		Pitch	Ordering Code	EDP No.	Dimensions [inch]			V6 Anvil	
	IC	L [inch]	tpi	RH	VKX	h	X	Y	RH	Toolholder
 <p>Defined by: B.S.84:1956, DIN 259, ISO228/1:1982 Tolerance class: Medium class A</p>	3/8" V6	.63	19	3ER19W-6C...	59539	.034	.07	.09	YE3-6C	AL...-3
			16	3ER16W-6C...	59540	.040	.06	.09		
			14	3ER14W-6C...	59541	.046	.07	.11		
			12	3ER12W-6C...	59542	.054	.08	.12		
<p>Internal</p>	3/8" V6	.63	19	3IR19W-6C...	59559	.034	.07	.09	YI3-6C	AVRC...-3 NVRC...-3V6
			16	3IR16W-6C...	59556	.040	.06	.09		
			14	3IR14W-6C...	59554	.046	.07	.10		
			12	3IR12W-6C...	59549	.054	.07	.10		

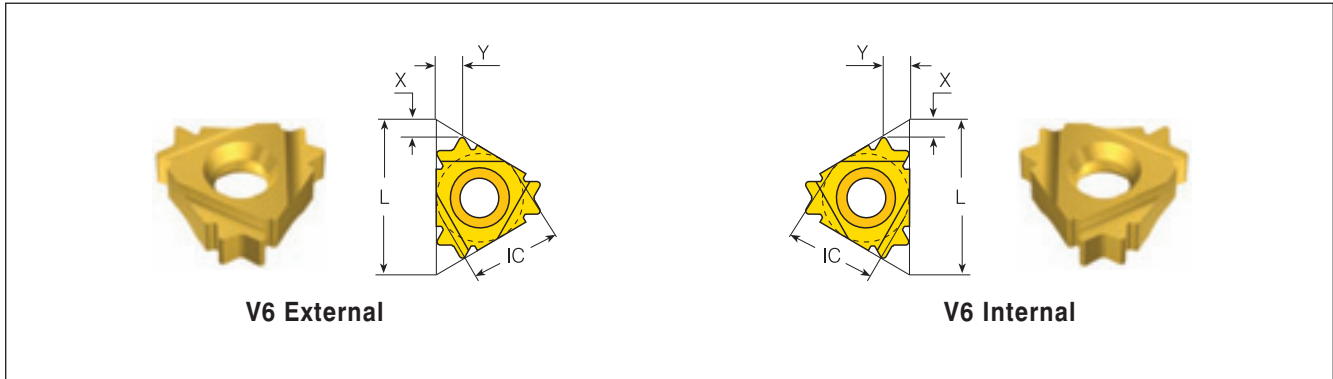

NPT

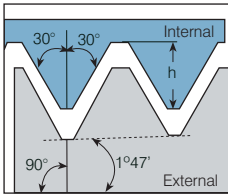

	Insert Size	Pitch	Ordering Code	EDP No.	Dimensions [inch]	V6 Anvil				
	IC	L [inch]	tpi	RH	VKX	h	X	Y	RH	Toolholder
External	3/8" V6	.63	14	3ER14NPT-6C...	59543	.052	.08	.12	YE3-6C	AL...-3
Internal	3/8" V6	.63	14	3IR14NPT-6C...	59551	.052	.08	.11	YI3-6C	AVRC...-3 NVRC...-3V6

Defined by: USAS B2.1:1968
Tolerance class: Standard NPT

BSPT

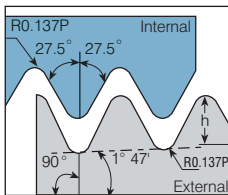

	Insert Size	Pitch	Ordering Code	EDP No.	Dimensions [inch]	V6 Anvil				
	IC	L [inch]	tpi	RH	VKX	h	X	Y	RH	Toolholder
External	3/8" V6	.63	19	3ER19BSPT-6C...	59544	.034	.07	.09	YE3-6C	AL...-3
			14	3ER14BSPT-6C...	59545	.046	.07	.11		
Internal	3/8" V6	.63	19	3IR19BSPT-6C...	59558	.034	.07	.09	YI3-6C	AVRC...-3 NVRC...-3V6
			14	3IR14BSPT-6C...	59552	.046	.08	.11		

Defined by: B.S.21:1985
Tolerance class: Standard BSPT

Important!

Use a V6 anvil when using a V6 insert.

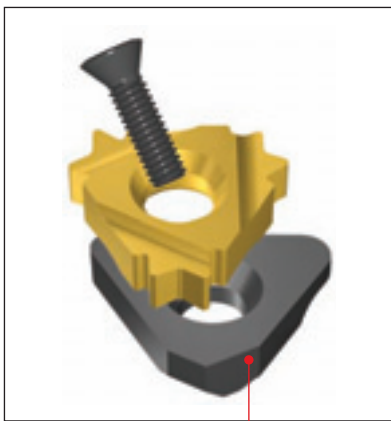

For External RH use YE3-6C anvil.

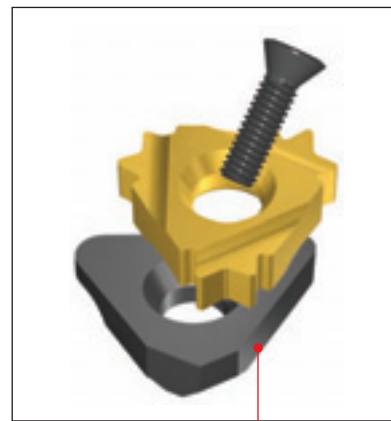

For Internal RH use YI3-6C anvil.

External Toolholders (with anvil)

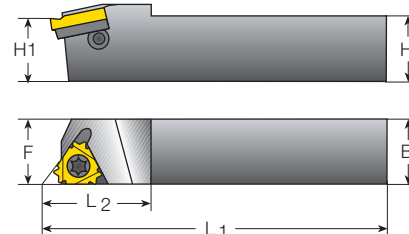
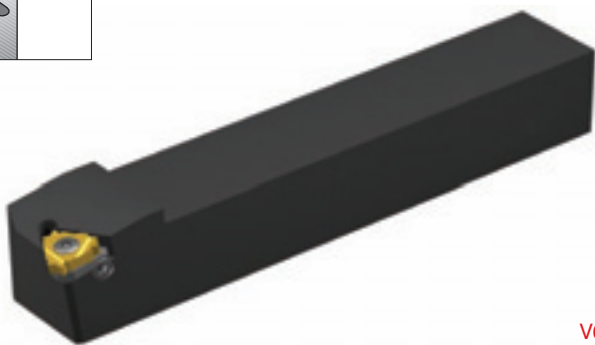
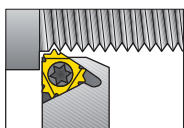

V6 inserts can be used on any External RH holder that uses an anvil.

Standard

Insert Size	Ordering Code	EDP No.	Dimensions [inch]				Spare Parts (Ordering code & EDP No.)			
			H=H1=B	F	L1	L2	Insert Screw	Anvil Screw	Torx Key	V6 Anvil RH *
3/8"	AL3/8-3	66091	.37	.63	2.45	.76	SA3T (70028)	SY3T (70044)	K3T (70021)	YE3-6C (70249)
	AL050-3	66000	.50	.63	3.27	.87				
	AL0625-3	66005	.63	.63	5.00	1.02				
	AL075-3	66007	.75	.75	5.00	1.02				
	AL100-3	66016	1.00	1.00	6.00	1.20				
	AL125-3	66036	1.25	1.25	7.00	1.18				

* The holders are supplied with standard anvils. For V6, please use the V6 anvil indicated in the table above.

External Toolholders (with anvil)

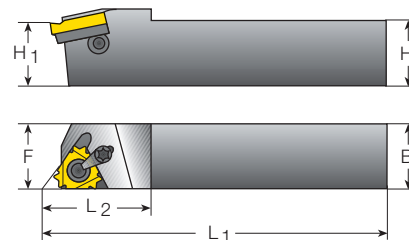
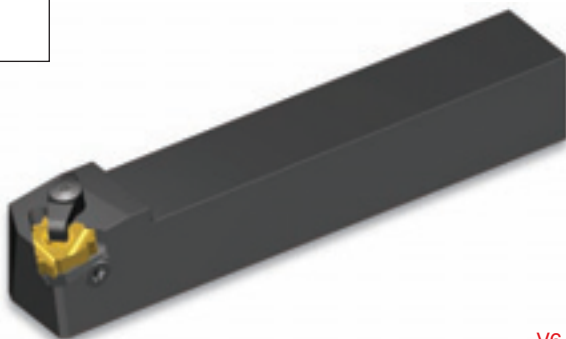
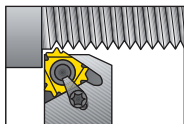

V6 inserts can be used on any External RH holder that uses an anvil.

Standard with Clamp

(Dual System: Screw or Clamp)

Insert Size	Ordering Code	EDP No.	Dimensions [inch]				Spare Parts (Ordering code & EDP No.)				
			H=H1=B	F	L1	L2	Insert Screw	Anvil Screw	Clamp	Torx Key	V6 Anvil RH *
3/8"	AL075-3C	66008	.75	.75	5.00	1.20	SA3T (70028)	SY3T (70044)	C3 (70017)	K3CT (70244)	YE3-6C (70249)
	AL100-3C	66017	1.00	1.00	6.00	1.20					
	AL125-3C	66031	1.25	1.25	7.00	1.20					

* The holders are supplied with standard anvils. For V6, please use the V6 anvil indicated in the table above.

External Toolholders (with anvil)

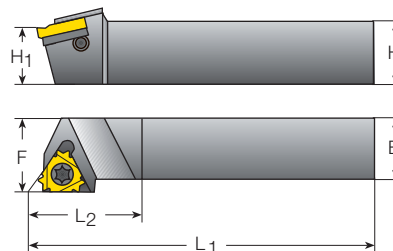
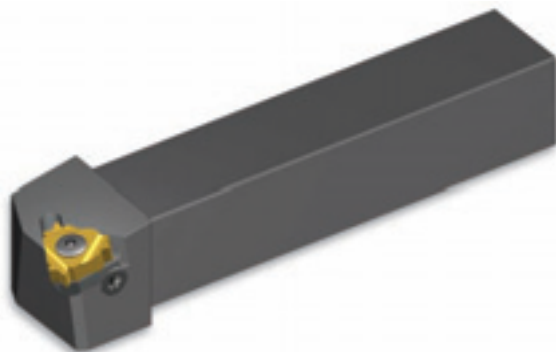
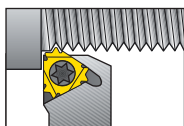

V6 inserts can be used on any External RH holder that uses an anvil.

Off-Set Qualified (FQ)

Insert Size	Ordering Code	EDP No.	Dimensions [inch]				Spare Parts (Ordering code & EDP No.)			
			H=H1=B	F	L1	L2	Insert Screw	Anvil Screw	Torx Key	V6 Anvil RH
3/8"	AL075-3FQ	66011	.75	.75	6.00	1.00	SA3T (70028)	SY3T (70044)	K3T (70021)	YE3-6C (70249)
	AL100-3FQ	66020	1.00	1.00	6.00	1.00				
	AL125-3FQ	66039	1.25	1.25	6.00	1.20				

* The holders are supplied with standard anvils. For V6, please use the V6 anvil indicated in the table above.

External Toolholders (with anvil)

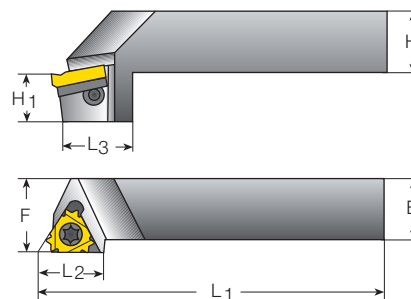
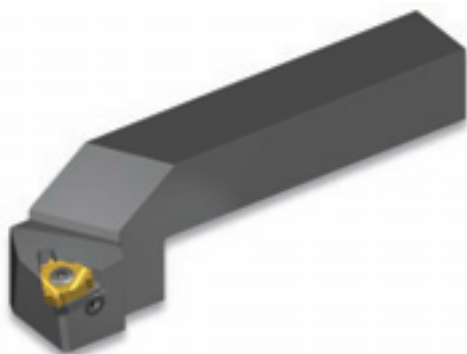
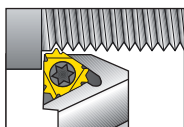

V6 inserts can be used on any External RH holder that uses an anvil.

Drop Head-Qualified (CQ)

Insert Size	Ordering Code	EDP No.	Dimensions [inch]						Spare Parts (Ordering code & EDP No.)			
			H=B	F	L1	L2	L3	H1	Insert Screw	Anvil Screw	Torx Key	V6 Anvil RH
3/8"	AL075-3CQ	66009	.75	1.00	5.00	.88	1.50	.69	SA3T (70028)	SY3T (70044)	K3T (70021)	YE3-6C (70249)
	AL100-3CQ	66018	1.00	1.25	6.00	.88	1.50	.87				
	AL125-3CQ	66037	1.25	1.5	7.00	.88	1.50	.87				

* The holders are supplied with standard anvils. For V6, please use the V6 anvil indicated in the table above.

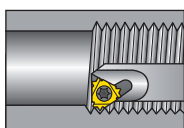

Internal Toolholders (with anvil)

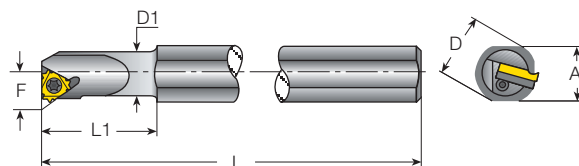

V6 inserts can be used on any Internal RH holder that uses an anvil.

Standard

Insert Size	Ordering Code	EDP No.	Dimensions [inch]							Min. Bore dia.	Spare Parts (Ordering code & EDP No.)			
			A	L	L1	D	D1	F	inch		Insert Screw	Anvil Screw	Torx Key	V6 Anvil RH*
3/8"	AVRC075-3	66098	.67	7.0	1.50	.75	.75	.51	.90	SA3T (70028)	SY3T (70044)	K3T (70021)	Y13-6C (70256)	
	AVRC100-3	66100	1.12	10.0	2.50	1.25	1.00	.65	1.20					
	AVRC100D-3	66104	.90	8.0	1.75	1.00	1.00	.65	1.20					
	AVRC125-3	66108	1.12	10.0	2.50	1.25	1.25	.77	1.45					
	AVRC150-3	66114	1.34	12.0	2.50	1.50	1.50	.90	1.65					

* The holders are supplied with standard anvils. For V6, please use the V6 anvil indicated in the table above.

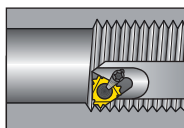

Internal Toolholders (with anvil)

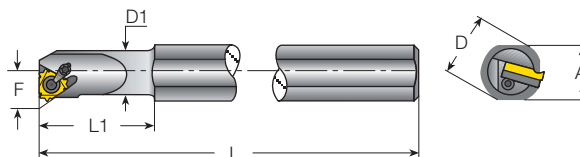

V6 inserts can be used on any Internal RH holder that uses an anvil.

Standard with Clamp

(Dual System: Screw or Clamp)

Insert Size	Ordering Code	EDP No.	Dimensions [inch]							Min. bore dia.	Spare Parts (Ordering code & EDP No.)				
			A	L	L1	D	D1	F	inch		Insert Screw	Anvil Screw	Clamp	Torx Key	V6 Anvil RH*
3/8"	AVRC075-3C	66032	.67	7.0	2.00	.75	.75	.51	.90	SA3T (70028)	SY3T (70044)	C3 (70017)	K3CT (70244)	Y13-6C (70256)	
	AVRC100-3C	66040	1.12	10.0	2.50	1.25	1.00	.65	1.20						
	AVRC100D-3C	66056	.90	8.0	1.75	1.00	1.00	.65	1.20						
	AVRC125-3C	66093	1.12	10.0	2.50	1.25	1.25	.77	1.45						
	AVRC150-3C	66096	1.34	12.0	2.50	1.50	1.50	.90	1.65						

* The holders are supplied with standard anvils. For V6, please use the V6 anvil indicated in the table above.

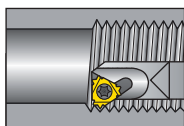

Internal Toolholders (with anvil)

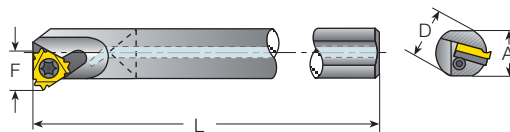

V6 inserts can be used on any Internal RH holder that uses an anvil.

Standard with Carbide Shank

Spare Parts (Ordering code & EDP No.)

Insert Size	Ordering Code	EDP No.	Dimensions [inch]					Min. bore dia. inch	Spare Parts (Ordering code & EDP No.)			
			D	A	F	L	Insert Screw		Anvil Screw	Torx Key	V6 Anvil RH	
3/8"	CAVRC075-3	66194	.75	.727	.509	10.00	.90	SA3T (70028)	SY3T (70044)	K3T (70021)	Y13-6C (70256)	

* The holders are supplied with standard anvils. For V6, please use the V6 anvil indicated in the table above.

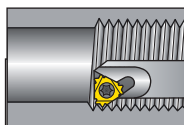

Internal Toolholders for V6 (without anvil)*

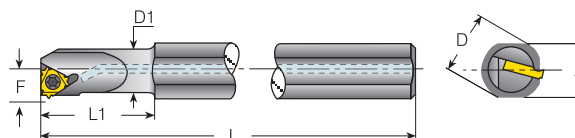

Specially designed for V6 inserts

V6 Style

Spare Parts (Ordering code & EDP No.)

Insert Size	Ordering Code	EDP No.	Dimensions [inch]						Min. bore dia. inch	Spare Parts (Ordering code & EDP No.)	
			A	L	L1	D	D1	F		Insert Screw	Torx Key
3/8" V6	NVRC050-3V6	66231	.67	7.0	1.25	.75	.50	.40	.67	SN3TM (70236)	K3T (70021)
	NVRC0625-3V6	66232	.67	7.0	1.50	.75	.62	.46	.80	SN3T (70038)	
	NVRC0625D-3V6	66233	.58	6.0	1.25	.62	.62	.46	.80		

The above toolholders have a 1.5° helix angle.

* V6 inserts cannot be used on standard internal toolholders without anvil. For this purpose you must use one of these special V6 toolholders.

Calculating the Helix Angle β

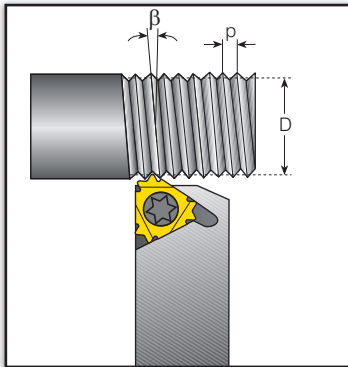

The helix angle is calculated by the following formula:

$$\beta = \arctan \frac{P \times N}{\pi \times D}$$

β - Helix angle [°]
 P - Pitch [Inch]
 N - No. of starts
 D - Pitch diameter [Inch]
 Lead = P x N

The helix angle can also be determined from the diagram below.

Helix Angle Diagram

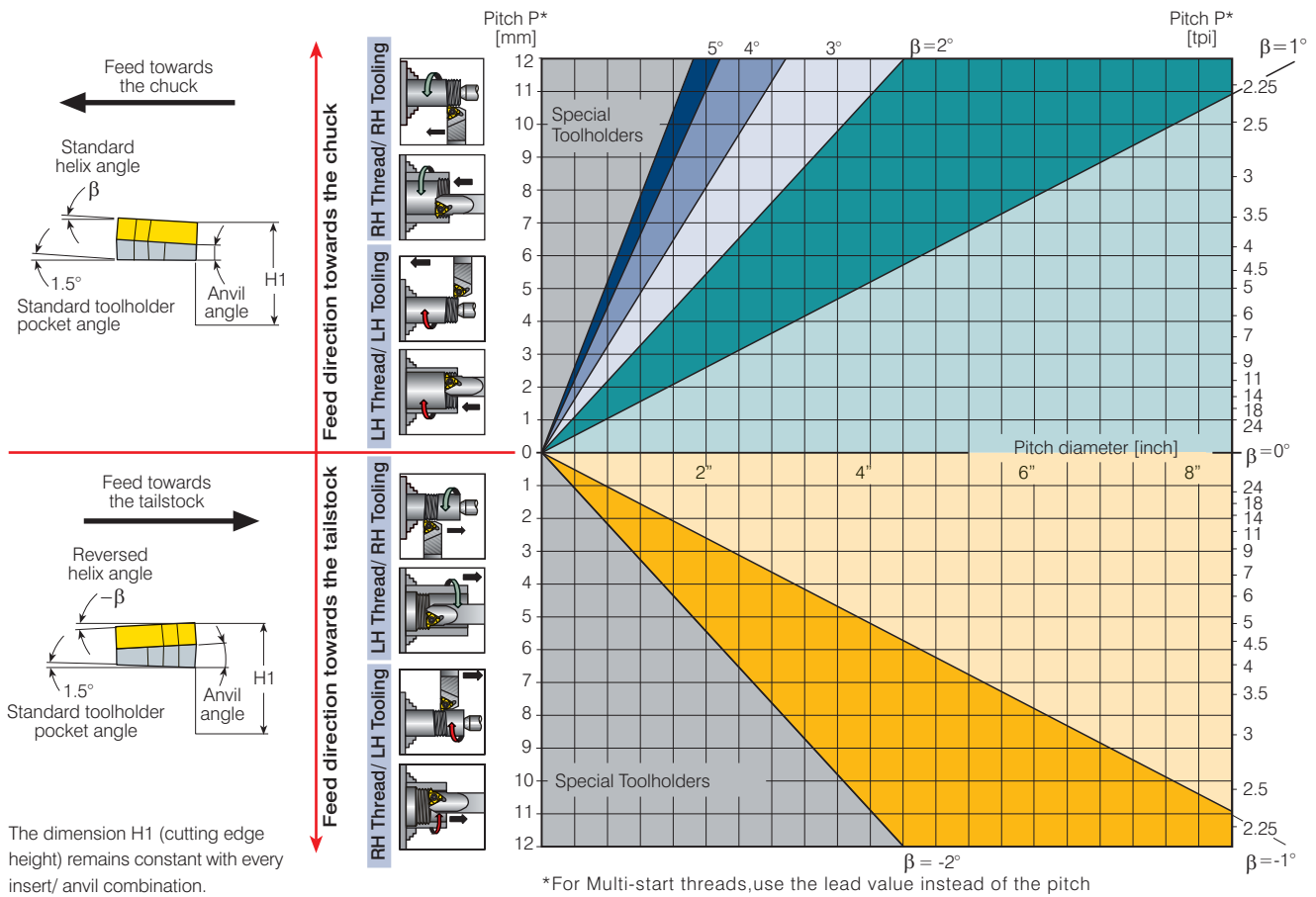

V6 Anvil

V6 is indicated on the backside



Resultant Helix Angle	4.5°	3.5°	2.5°	1.5°	0.5°	0°	-0.5°	-1.5°		
IC	L inch	Holder	Ordering Code(EDP No.)							
3/8" V6	.63	ER	YE3-6C-3P (70246)	YE3-6C-2P (70247)	YE3-6C-1P (70248)	YE3-6C (70249)	YE3-6C-1N (70250)	YE3-6C-1.5N (70258)	YE3-6C-2N (70251)	YE3-6C-3N (70252)
		IR	YI3-6C-3P (70253)	YI3-6C-2P (70254)	YI3-6C-1P (70255)	YI3-6C (70256)	YI3-6C-1N (70257)	YI3-6C-1.5N (70261)	YI3-6C-2N (70259)	YI3-6C-3N (70260)

Recommended Grades and Cutting Speeds Vc [ft/min]

Material Group	Vardex No.	Material		Hardness Brinell HB	Vc [ft/min]
					Coated VKX
P Steel	1	Unalloyed steel	Low carbon (C=0.1-0.25%)	125	377-623
	2		Medium carbon (C=0.25-0.55%)	150	328-574
	3		High carbon (C=0.55-0.85%)	170	295-541
	4	Low alloy steel (alloying elements ≤5%)	Non hardened	180	328-590
	5		Hardened	275	246-459
	6		Hardened	350	230-443
	7	High alloy steel (alloying elements >5%)	Annealed	200	262-394
	8		Hardened	325	164-328
	9	Cast steel	Low alloy (alloying elements <5%)	200	230-426
	10		High alloy (alloying elements >5%)	225	197-394
M Stainless Steel	11	Stainless steel Ferritic	Non hardened	200	230-426
	12		Hardened	330	197-377
	13	Stainless steel Austenitic	Austenitic	180	295-459
	14		Super Austenitic	200	131-361
	15	Stainless steel Cast ferritic	Non hardened	200	295-394
	16		Hardened	330	213-361
	17	Stainless steel Cast austenitic	Austenitic	200	279-361
	18		Hardened	330	197-328
K Cast Iron	28	Malleable Cast iron	Ferritic (short chips)	130	197-230
	29		Pearlitic (long chips)	230	197-476
	30	Grey Cast iron	Low tensile strength	180	230-426
	31		High tensile strength	260	197-377
	32	Nodular SG iron	Ferritic	160	410-525
	33		Pearlitic	260	295-394
N(K) Non-Ferrous Metals	34	Aluminium alloys Wrought	Non aging	60	328-1197
	35		Aged	100	262-722
	36	Aluminium alloys	Cast	75	656-1312
	37		Cast & aged	90	656-918
	38		Cast Si 13-22%	130	197-590
	39	Copper and copper alloys	Brass	90	262-738
	40		Bronze and non leaded copper	100	262-836
S(M) Heat Resistant Material	19	High temperature alloys	Annealed (Iron based)	200	148-197
	20		Aged (Iron based)	280	98-164
	21		Annealed (Nickel or Cobalt based)	250	66-98
	22		Aged (Nickel or Cobalt based)	350	49-82
	23	Titanium alloys	Pure 99.5 Ti	400Rm	459-558
	24		α+β alloys	1050Rm	164-230
H(K) Hardened Material	25	Extra hard steel	Hardened & tempered	45-50HRc	148-197
	26			51-55HRc	131-164

Calculation of N [RPM]

$$N = \frac{12 \times V_c}{\pi \times D}$$

$$V_c = \frac{N \times \pi \times D}{12}$$

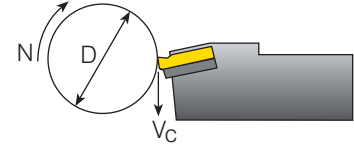

N - Revolution Per Minute [RPM]
 V_c - Cutting Speed [ft/min]
 D - Workpiece Diameter [Inch]

VKX



Excellent grade for general use.

Number of Passes

Pitch	mm	0.50	0.75	1.00	1.25	1.50	1.75	2.00
	tpi		48	32	24	20	16	14
No. of passes		3-6	3-6	4-8	4-8	5-9	6-11	6-11



V6
6 Cutting Corners

VARDEX
Advanced Threading Solutions

maXmark
INCORPORATED

vargus
NEUMO Ehrenberg Group

Vargus USA
1149 Barberry Drive
Janesville, WI 53545 U.S.A

Tel: +1-800-828-8765
+1-608-756-4930
Fax: +1-608-741-7125

sales@vargususa.com
www.vargususa.com

221-00949
INCH EE
11/2009
Edition 01